

# CONTENTS

Speed Hump Embedded EPDM 01



Reflective Speed Hump 01



Arrow Speed Bump 04



Speed Hump [Coated EPDM] 05



Rumble Stripe 06



Portable Speed Hump 07



Around Speed Hump 08



Speed Cushion 09



Pedestrian Crossing 10



Black Base PVC Traffic Cone 11



Orange Base PVC Traffic Cone 12



European Standard PVC Traffic Cone 13



Rubber Traffic Cone 14



PE Traffic Cone 14



Folding Traffic Cone 14



Traffic Cone Topper 15



Traffic Cone Bar 15



Traffic Cone Sign 15



Traffic Cone Collar 15



Solar Traffic Cone Kamp 16



PU Flexible Post 17



EVA Flexible Post 17



Flexible Guide Bollard 18



Delineator Post 19



Delineator Cone 19



Delineator Panel (American Standard) 20



Delineator Panel (EU Standard) 20



Delineator Panel (North EU Standard) 20



Lane Separator 21



Lane Divider 22



Plastic Safety Fence 22



Expandable Barrier 23



Plastic Fence Barrier 24



Australia Barrier Board 24



Water Filled Barrier 25



Convex Mirror 26



Road Stud 27



Temporary Road Marking 27



Guiderrail Reflector 28



Guide Post 28



Barricade Light 29



Plastic Chain 29



Traffic Flag 30



Traffic Baton 30



Anti Glare Panel 30



Caution Tape 31



Permanent Marking Tape 31



Hazard Warning Tape 31



Rubber Cable Protector 32



PU Cable Protector 35



Cable Cover 37



Cord Protector 38



Hose Ramp 39



Kerb Ramp 40



Rubber Wheel Chock 42



Plastic Wheel Chock 42



Wheel Stopper 44



Corner Guard 46



Wall Protector 47



D-Type Dock Bumper 48



Molded Dock Bumper 48



Floor Sign 49



Rampway Anti-Skidding Mat 49



Steel Safety Bollard 49



Parking Lock 50



Bike Rack 50



## Speed Hump

Yellow EPDM Rubber Embedded

Molded Yellow Rubber Piece for longer service life!

Now most speed humps are glued Yellow Reflective Tape, normally the reflective tape would be only last 1-2 years maximum service life.

But Eastsea Rubber embed the yellow EPDM rubber into speed hump through a special process, the yellow rubber will not be fade, fallen, crack under any conditions and environment.

Further Eastsea Rubber provide 5 years quality assurance for all [Yellow EPDM Rubber Embedded] Speed Humps.



6 Foot Speed Bump

Model No: DH-SP-26

Middle: 1830 x 300 x 50MM

End Cap: 190 x 300 x 50MM

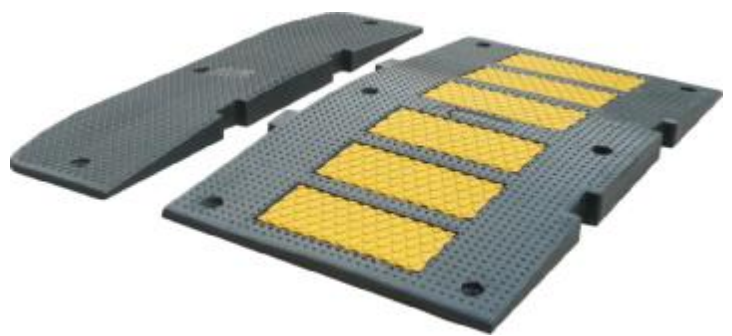
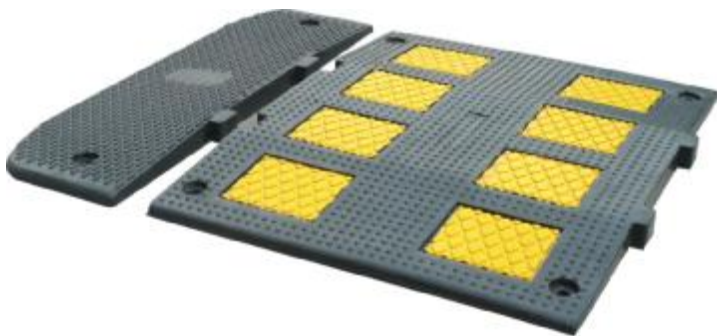

Model	Middle Size	End Cap Size
DH-SP-21	500x600x32mm	200x600x32mm

Model	Middle Size	End Cap Size
DH-SP-22	500x900x50mm	200x900x50mm



Model	Middle Size	End Cap Size
DH-SP-12	500x900x50mm	200x900x50mm

Model	Middle Size	End Cap Size
DH-SP-14	500x1100x75mm	200x1100x75mm

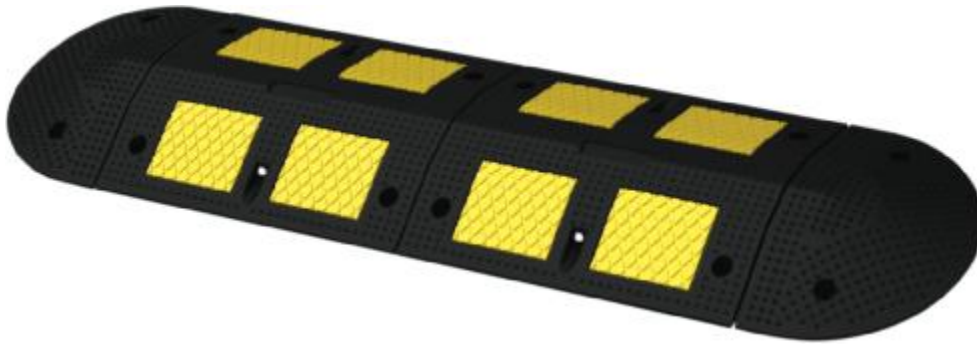

**75MM Speed Bump**

**Model No: DH-SP-23**

**Middle: 500 x400 x75MM**

**End Cap: 250 x 400 x75MM**

**Speed Hump** Yellow Bead Reflective Tape Bonded

*Bead tapes provide High visibility to driver in the day & night!*

*These Speed Hump are bonded with yellow bead reflective tape [Preformed thermoplastic pavement markings] by Super glue. The bead tapes provide High visibility to driver in the day & night*



**Reflective Speed Bump**

**Model No: DH-SP-24**

**Middle: 500 x 350 x 50MM**

**End Cap: 250 x 350 x 50MM**



**3 Foot Speed Bump**

**Model No: DH-SP-28**

**Middle: 900 x 300 x 50MM**

**End Cap: 190 x 300 x 50MM**



**4Foot Speed Bump**

**Model No: DH-SP-29**

**Middle: 1200 x 300 x 50MM**

**End Cap: 190 x 300 x 50MM**



**6 Foot Speed Bump**

**Model No: DH-SP-6**

**Middle: 1830 x 300 x 50MM**

**End Cap: 190 x 300 x 50MM**



**6 Foot Speed Bump [75MM]**

**Model No: DH-SP-75**

**Middle: 1830 x 300 x 75MM**

**End Cap: 190 x 300 x 75MM**

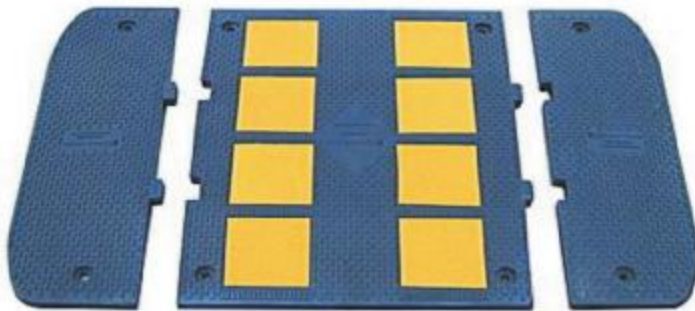

Model	Middle Size	End Cap Size
DH-SP-1	500x600x32mm	200x600x32mm

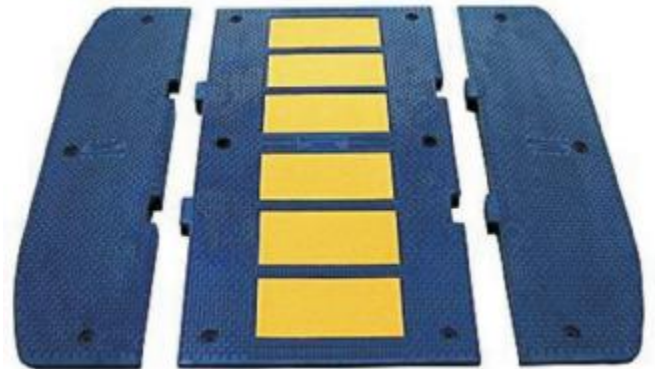

Model	Middle Size	End Cap Size
DH-SP-2	500x900x50mm	250x900x50mm



Model	Middle Size	End Cap Size
DH-SP-11	500x500x50mm	250x500x50mm

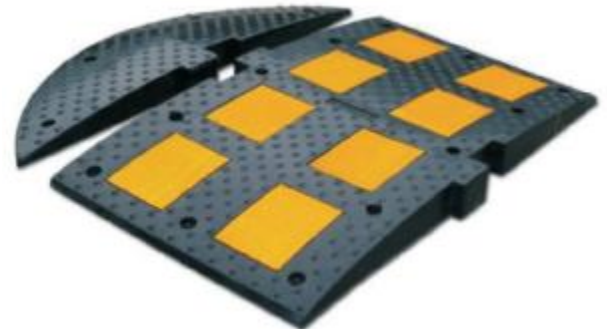

Model	Middle Size	End Cap Size
DH-SP-16	500x900x50mm	250x900x50mm

**Arrow Speed Hump** Yellow EPDM Coated & Bead Tape Bonded

High Visibility Yellow Rubber and Bead Reflector.

*The Arrow Speed Humps are designed for heavy traffic roads in High-Class Markets . The wide body yellow rubber section and white arrow reflector provide maximal visibility to driver in the day & night. Further More, the wide body speed hump help the car / truck run over the speed hump line smoothly without severe shock.*



**YELLOW RUBBER PIGMENT IS GUARANTEED BY CIBA® WITHIN 2 YEARS!**

Model	Part	Length	Width	Height	Weight
DH-SP-8	Middle	500mm	550mm	75mm	14kg
	End Cap	250mm	550mm	75mm	8kg



Model	Part	Length	Width	Height	Weight
DH-SP-5	Middle	500mm	1000mm	75mm	23kg
	End Cap	250mm	1000mm	75mm	9.0kg



**European Speed Hump**

Yellow EPDM Rubber Coated

Yellow Rubber Pigment is Guaranteed By CIBA® within 2 years!

All of these series Speed Hump are made from durable recycle tire rubber with Yellow EPDM coating. The yellow /black rubber will not be fade, fallen, crack under any conditions and environment. Eastsea Rubber provide 2-year quality assurance for all [Yellow EPDM Rubber Coated] Speed Humps.



Model	Middle Size	End Cap Size
DH-SP-7	500x400x50mm	200x400x50mm



Model	Middle Size	End Cap Size
DH-SP-13	500x400x75mm	250x400x75mm



Model	Middle Size	End Cap Size
DH-SP-9	500x400x40mm	250x400x40mm



Model	Middle Size	End Cap Size
DH-SP-10	330x500x45mm	250x500x45mm



Model	Middle Size	End Cap Size
DH-215	500x350x50mm	250x350x50mm
DH-217	250x350x50mm	250x350x50mm



Model	Middle Size	End Cap Size
DH-209	1000x350x50mm	250x350x50mm



## Gereneel Speed Hump

Yellow EPDM Rubber Coated



Model	Middle Size	End Cap Size
DH-211	1000x300x45mm	250x300x45mm
DH-208	1000x330x50mm	250x330x50mm
DH-212	1000x380x50mm	250x380x50mm

Yellow Rubber Pigment is Guaranteed By CIBA® within 2 years!



Model	Middle Size	End Cap Size
DH-213	1000x300x45mm	250x300x45mm
DH-214	1000x380x50mm	250x380x50mm

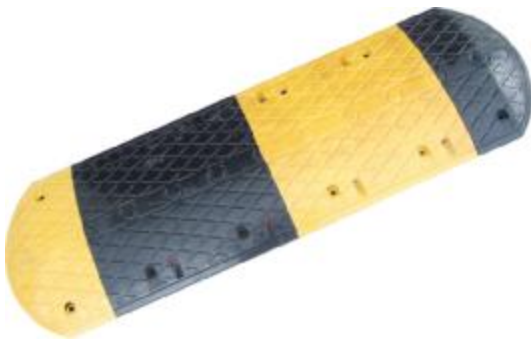

Model	Middle Size	End Cap Size
DH-216	1000x450x60mm	250x450x60mm



Model	Middle Size	End Cap Size
DH-210	1000x250x35mm	250x250x35mm

## PU Rumble Strips

Yellow Injection PU



A durable and versatile Polyurethane rumble strip for use as a speed moderator or lane divider on roadways. Ideal in residential complexes to slow the flow of vehicles. Alternatively, it can be used as a wall mounted bump protector. Manufactured from PU, 500mm long x 100mm wide x 15mm thick. Can be installed with appropriate masonry fixings or glued using a suitable adhesive.

Model	Middle Size	Weight
DH-SP-3	500x100x15mm	1.5Kg /Piece



## Portable Speed Hump

Eastsea Portable speed bumps are made from durable PU materials that have all the benefits of stationary speed bumps, but can be folded up and moved from location to location in seconds. Perfect for calming traffic during certain hours of the day, such as immediately before and after school, Eastsea portable, foldable speed bumps weigh less than 12kg and are easily handled by one person.



Model No	Max Length	Width	Height	Weight	Fold Size	Bearing Weight
DH-PSP-1	3000mm	250mm	25mm	11kg	360x250x310mm	20Tons



**Installation Easily, No screws / adhesive required.**

**Highly visible and reflective at Night.**

**Usable in all weather conditions.**

**Can withstand any size vehicle.**

**Easy to removal and roll up back into carry case.**

**Polyurethane Raw Materials.**



**Portable Speed Hump** | PP Materials

The highly visible system is designed for temporary speed control applications, where it is desired to slow traffic speeds to 40km/hr. The secret behind the success of the system is its unique 'waffle-style' rubber underlay, which maximises adhesion to the road surface as vehicles traverse. It has been designed for use around highway work zones to assist in reducing speeds and therefore.



Model No	Max Length	Width	Height	Weight	Roll Up Size	Bearing Weight
DH-PSP-2	3000mm	250mm	45mm	13kg	540mm Dia	10Tons

**Round Solar Speed Hump** | PU Materials



Made Yellow Polyurethane Raw Materials.

Injecting the Screw Nut into the Base together.

Solar Road Stud, Fixed for High visibility

6PCS Led Flashing at Night

Model No	Diameter	Height	Weight	Bearing Weight	Materials	Flash LED
DH-SP-27	300mm	45mm	2.0Kg	10Tons	PU	6PCS LED



## Rubber Speed Cushion

Rubber Speed Cushions are made from recycled rubber tires. Rubber is lighter and easier to work with than asphalt and concrete, significantly minimizing the number of hours that need to be invested to install the solutions. Embedded reflective material increases visibility and safety, day or night.

### Red Ral3003 Color

### Black Color

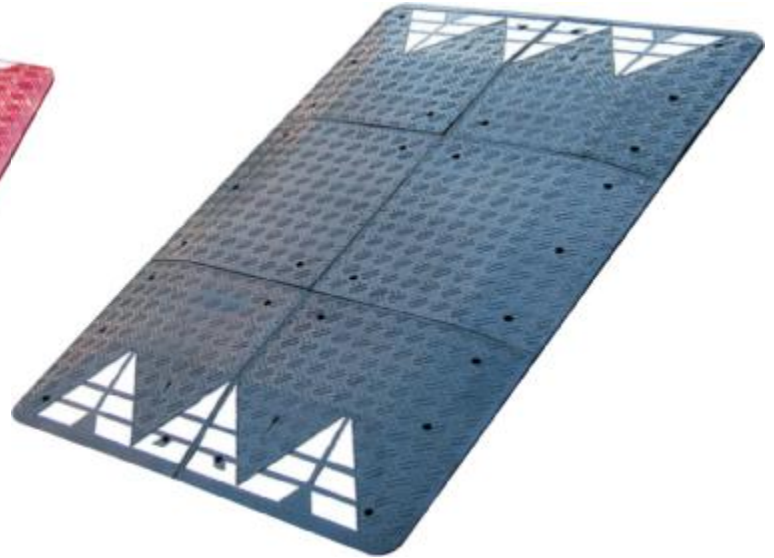

Model No	Total Length	Total Width	Height	Total Weight	Part	Dimension	Weight
DH-SP-4	3000MM	1800mm	65mm	300Kg	Left End	1000x900x65mm	45kg
					Middle	1000x900x65mm	50kg
					Right End	1000x900x65mm	45kg

### Installation Accessories:



## Rubber Pedestrian Crossing



- Completely made of vulcanized rubber movable modular parts.
- The upper surface has particular not slippery surface raised stud.
- Fixed to the ground by expansion screws and Bone Connector.
- The particular size of the modular parts may be used to meet any road.
- High-Intensity Reflective Pedestrian Crossing Sign Privode Better Night Visibility.

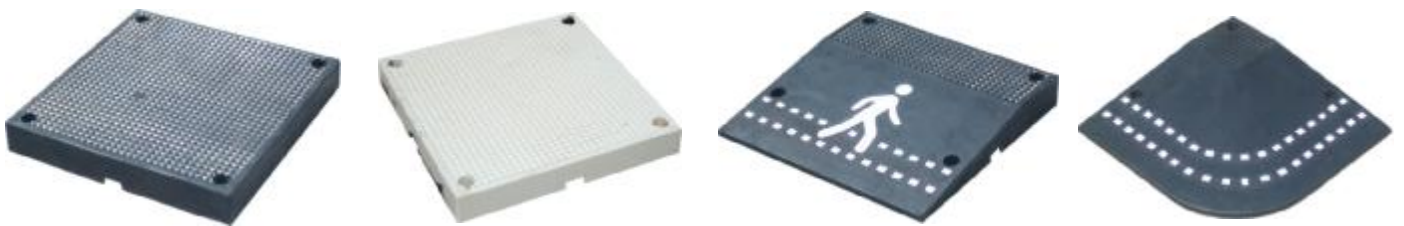

Model	Part	Dimension	Weight	Accessories
PC-B	Black Middle	500x500x70mm	17.00kg	
PC-W	White Middle	500x500x70mm	17.00kg	
PC-E	End Cap	500x500x70mm	12.00kg	
PC-R	End Cap	500x500x70mm	11.00kg	

*The Pedestrian Crossing speeds up the running vehicles, giving them a vertical acceleration as strong as the vehicle speed: this characteristics wants to push the drivers to limit their speed, avoiding dangerous situations, specially for two wheels vehicles, and avoiding problems to who circulates at normal speed.*



**Black Base PVC Traffic Cone | America & Australia Model**

Eastsea PVC Traffic Cones are made up of Fluorescence Orange PVC Cone Body and Recycle Materials Back Base. The two parts interlock as a single inseparable piece, and would not separate even truck run over them.



ITEM NO	HEIGHT	BASE WIDTH	CONE DIAMETER	WEIGHT	REFLEX
DH-TC-30	300MM	220MM	140MM	1.1KG	No
DH-TC-45	450MM	270MM	190MM	1.5KG	100MM
DH-TC-70	710MM	360MM	230MM	3.0KG	100MM 150MM
DH-TC-70W Wide Body	710MM	360MM	260MM	3.3KG	100MM 150MM
DH-TC-70B Wide Body	710MM	360MM	260MM	4.5KG	100MM 150MM
DH-TC-90	910MM	360MM	230MM	4.5KG	100MM 150MM
DH-TC-90B	910MM	360MM	230MM	5.5KG	100MM 150MM



**Orange Base PVC Traffic Cone | General Model**

Single Piece Made from Fluorescence Orange PVC

Environmentally friendly – 100% recyclable!

Extreme durability & superior flexibility !



ITEM NO	HEIGHT	BASE WIDTH	CONE DIAMETER	WEIGHT	REFLEX
DH-TC-30R	300MM	220MM	140MM	0.7KG	No
DH-TC-45R	450MM	270MM	190MM	1.1KG	100MM
DH-TC-70R	710MM	400MM	260MM	2.3KG	150MM 100MM
DH-TC-90R	910MM	280MM	260MM	4.5KG	150MM 100MM



**PVC Traffic Cone | European Model**



Recessed Handle for easy carry and moving

Meet Most European Countries Standards

ITEM NO	HEIGHT	BASE WIDTH	CONE DIAMETER	WEIGHT	REFLEX
DH-TC-75R	750MM	220MM	280MM	4.2KG	150MM 150MM
DH-TC-50R	500MM	270MM	200MM	1.0KG	100MM 100MM
DH-TC-75	750MM	400MM	280MM	4.2KG	150MM 150MM
DH-TC-50	500MM	280MM	200MM	2.0KG	100MM 100MM

**WHAT'S THE ADVANTAGE OF INTERLOCK PVC TRAFFIC CONE WITH PE AND RUBBER TRAFFIC CONE:**

1. The Rubber traffic cones were painted red, but the painting often peel off automatically after several month.
2. The PE traffic cone body was often drop away from rubber base as they were not a inseparable piece.
3. The unique formulation of the Orange Interlock Traffic Cone prevents that it loses its color within 3 years.
4. The unique construction of Interlock design prevents that the body won't be separated from base no matter how many weight bearing.



### Rubber Traffic Cone

Made From recycle Tire Rubber and Painted Red and White.



Model No	DH-LZ-1	DH-LZ-2	DH-LZ-3	DH-LZ-4	DH-LZ-5	DH-LZ-6
Base	280mm	350mm	280mm	350mm	280mm	350mm
Height	500mm	700mm	500mm	700mm	500mm	700mm
Weight	1.5Kg	2.2Kg	2.0Kg	2.8Kg	2.0Kg	2.8Kg

### PE Traffic Cone

Blowing PE Cone Body locked with Recycle Rubber Base.



Model No	DH-PE-1	DH-PE-2	DH-PE-3	DH-PE-4	DH-PE-5	DH-PE-6
Base	280mm	350mm	490mm	400mm	350mm	260mm
Height	500mm	700mm	1000mm	750mm	750mm	500mm
Weight	1.5Kg	2.5Kg	5.0Kg	4.0Kg	2.0Kg	0.6Kg

### Folding Traffic Cone



Model No	Height	Base Width	Base Height	Weight
DH-RC-30	300mm	190mm	27mm	0.45Kg
DH-RC-45	450mm	250mm	36mm	0.60Kg
DH-RC-50	500mm	250mm	36mm	0.65Kg
DH-RC-55	550mm	310mm	36mm	0.80Kg
DH-RC-70	700mm	310mm	50mm	1.1Kg
DH-RC-90	900mm	440mm	60mm	2.0Kg

### Retractable Traffic Cone Topper

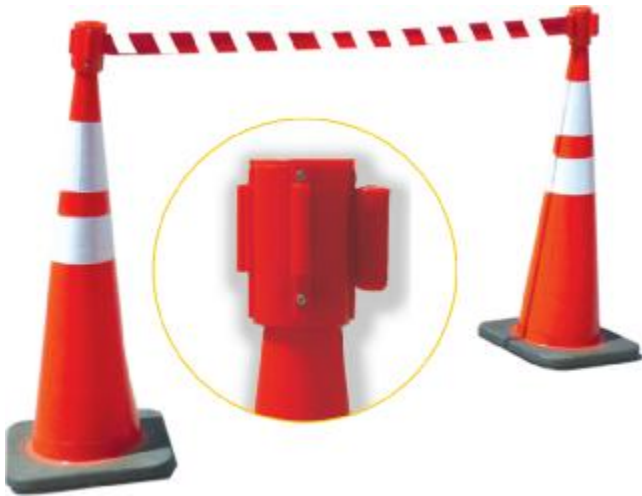

Red and White diagonal stripes belt and is conveniently designed to fit over most standard traffic cones.

With its 4 way connectivity, it is easy to use and proves to be a quick and effective way to restrict access.

### Products Dimension

Tape Length: 5.0Meter Tape Width: 50MM

Available Color: White/Red; Yellow / Black;

Height: 200MM / Width: 100MM

### Retractable Traffic Cone Bar



Black and yellow stripes for visual intensity. Retractable from 1150MM to 2500MM. Used in combination with the traffic cones, these cone bars form a temporary barrier. Controlling crowds and warning of road hazards and directing the traffic.

### Products Dimension

Original Length: 1300MM;

Expand Length: 2300MM

Pole Dia: 40MM; O-Ring Diameter: 105MM

Available Color: White/Red; Yellow / Black;

### Traffic Cone Sign



Model No

DH-TC-S1

Dimension

323MM x 266MM x 5MM

Specially cut grooves attach securely to traffic cone and are easily removed. Customize any words traffic cone sign to meet your needs.

### Traffic Cone Collar



Engineer Grade Reflective Sleeve



High Intensity Self-Adhesive Reflective Sheeting



Reflexite® High-Intensity Reflective Sleeve

**Solar Traffic Cone Lamp**

Model: SL-1



0.3W Solar Panel

4pcs Flash LED Inside

High-Intensity Tape

Light Control Switch

4CM Leg for Insert into Cone Topper.

**Flash Traffic Cone Lamp**

Model: SL-2



4pcs Flash LED Inside, Automatically Turn On At Night; 500meter Visual

2pcs D-Batteries inside, 500Hours Continuous working time.

Cone-Shape Cover for fitting onto various Cones.

**Flash Traffic Cone Bar**

Model: SL-3



105MM O-Ring For Fixing onto Traffic Cone Topper Conveniently.



3PCS AA Batteries Inside.

2.0Meter Length and 10MM Diameter Bar; 10PCS Super Bright LED inside for providing Obvious Flashing Lighting at Night.

## PU Flexible Post

PU FLEXIBLE POST PROVIDES FLEXIBILITY AND DURABILITY IN THE EVENT OF RUN OVER BY HEAVY VEHICLE.



Name	PU Flexible Post		EVA Flexible Post	
Model No	DH-FP-80	DH-FP-45	DH-FP-EVA-80	DH-FP-EVA-45
Height	750MM	450MM	800MM	450MM
Base With	200MM	200MM	200MM	200MM
Post Diameter	100MM	100MM	80MM	80MM
Weight	1.3KG	0.8KG	0.8Kg	0.6Kg
Bearing Capacity	10,000KG	10,000KG	1,000KG	1,000Kg

1. Made from most durable polyurethane .
2. High Impact Resistance and returns to vertical every time after impact .
3. Has a longer life than plastic or fiber-glass composite .
4. Good character of reflectivity based on the unique reflective sheet imported from Reflexive and the sheet with glue on the back is hard to desquamate from the body .
5. Little Maintenance and easy installation .
6. Heat Resistant +80°C, Cold Resistant -60°C.



## Flexible Guide Bollard

FLEXIBLE GUIDE BOLLARD PROVIDES FLEXIBILITY AND DURABILITY IN THE EVENT OF RUN OVER BY HEAVY VEHICLE.



Item No	Height	Base Width	Post Diameter	Weight	Reflex
DH-FB-75	750mm	200mm	200mm	1.8Kg	2x10CM

*The Guide Posts are made of Flexible EVA and designed for road separator & delineator. Molded the Screws and Washer in the base together for easily installation. High Impact Resistance and returns to vertical every time after impact. Applied High-Intensity Reflective tape for providing High visibility to driver in the day & night.*

**Available in different colors**



**T-Top Delineator Post**



**T-Top Delineator Post**  
Molded lower handhold grip



**Loop-Top Delineator Post**



Model No	Post Dia	Height	Base Width	Reflex Height	Base Weight	Total Weight
DH-GC-1	100MM	1150mm	420mm	25CM 2x10CM	6.0Kg/8.0Kg	7.0Kg/8.0Kg
DH-GC-3	100MM	1150mm	420mm	25CM 2x10CM	6.0Kg/8.0Kg	7.0Kg/8.0Kg
DH-GC-4	100MM	1150mm	420mm	2x10CM	6.0Kg/8.0Kg	7.0Kg/8.0Kg

Standard with molded lower handhold grip;  
 Convenient T-top carry handle and molded in bolt hole for flashing light;  
 Improved recesses create a deeper area for reflective bands;  
 Stronger ribs provide maximum band protection.

**Stackable T-Top Delineator Cone**

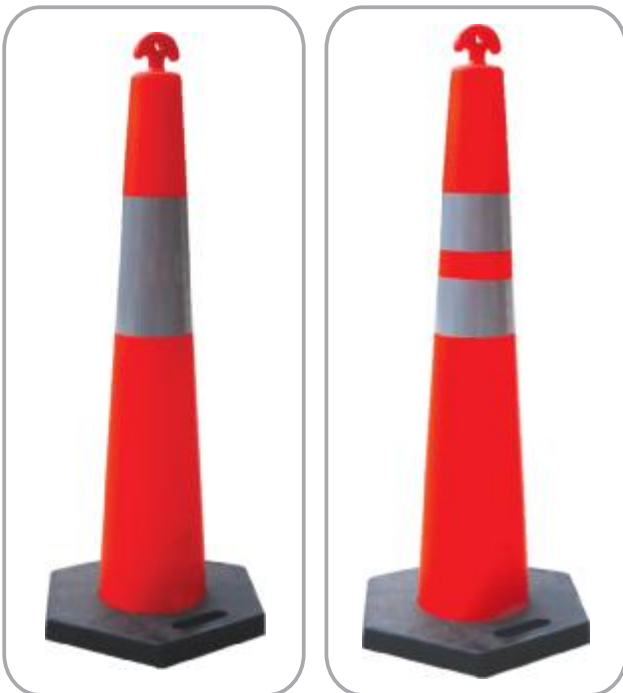

Flexible polyethylene post with reflective striping.  
 Sturdy 8 kg recycled rubber base.  
 Two-piece design for ease in storage & handling.

**Model No:** DH-GC-2

**Height:** 1150MM

**Base With:** 420MM

**Weight:** 8.0Kg

**Reflex:** 2x10CM/25CM High-Intensity Reflective Tape

**T-Top Accessories**

T-Top Chain Lock

Barricade Light



**Delineator Panel**



Model No	Height	Base Width	Panel Width	Weight
DH-VB-1	1100mm	490mm	300mm	13.0Kg



Model No	Height	Base Width	Panel Width	Weight
DH-VB-2	1100mm	800mm 400mm	250mm	22.0Kg



Model No	Height	Base Width	Panel Width	Weight
DH-VB-3	1100mm	670mm 380mm	250mm	16.0Kg



## Traffic Lane Separator System



Model No	Part	Length	Width	Thickness	Post Height	Weight	Color
DH-TS-M	Middle	1000mm	275mm	85mm	900MM	15Kg	Black/Yellow
DH-TS-E	End Cap	500mm	275mm	85mm	No	8Kg	Black



**T-Shape Connector**



**Design for Post**



**End Cap**

*Lande Separator are ideal for merges, gores, eliminating prohibited left turns, circles, work zones, and bicycle lane protection.*

Made From Recycle Rubber; Highly visible raised sections keep motorists in lanes;

Emergency vehicles can cross over separators without losing control;

Excellent durability and low life cycle costs;



**Rebounded Lane Divider**



Model No	Height	Base Size	Materials	Weight	Color
DH-300	300mm	220x150mm	Nature Rubber	1.5Kg	Yellow
DH-302	300mm	220x150mm	Nature Rubber	1.5Kg	Yellow

*A flexible flag with vivid color installed on a base is very easy noticed by driver while driving; Flag with reflective sheet work normally in night and bad weather, such as rain or snow; The flag is made from flexible rubber with the best flexible character and vivid color;*

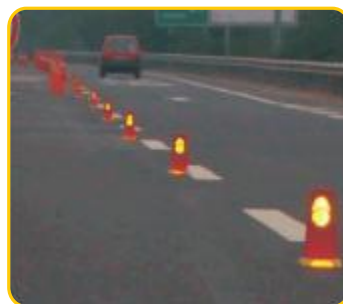

**Plastic Safety Fence**

*It adopts PE as major raw material with UV added in manufactured through plasticizing. The main color is orange, designed for warning.*

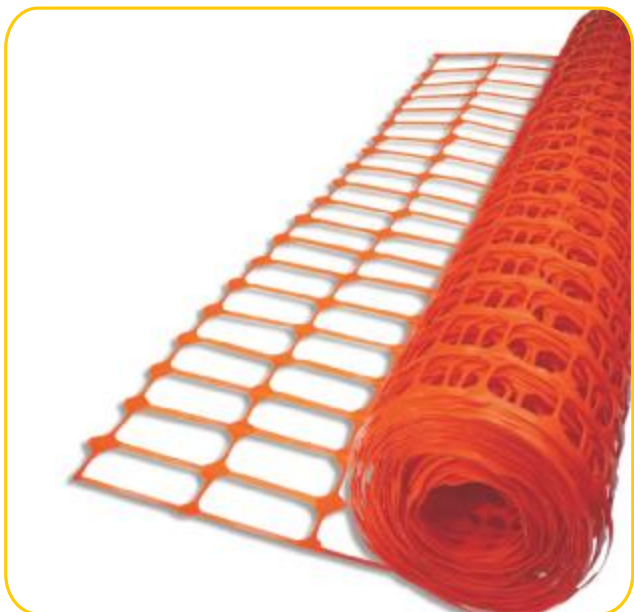

Model No	Height	Length	Mesh Size	Weight/ SQ.M	Total Weight
BR-114	1.0 M	50 M	100x40mm	120g	6.0Kg
BR-1214	1.2 M	50 M	100x40mm	120g	7.2kg
BR-1514	1.5 M	50 M	100x40mm	120g	9.0Kg
BR-1814	1.8 M	50 M	100x40mm	120g	10.8Kg



## Expandable Barrier

Made of Durable plastic, this easy to handle barrier is an ideal safety or traffic control unit. It is durable, maintenance free, temperature resistant, and will not damage or scratch floors. This barricade can link together with other like units for additional security. Some minor assembly is required.



**MADE FROM DURABLE PLASTIC BY INJECTION**

**EXPANDABLE FROM 420MM TO 3500MM**

**DETACHABLE RUBBER LEGS TO ENHANCE RELIABILITY**

Model No	Shorten Length	Extension Length	Width	Height	Weight	Color
DH-EB-1	450mm	3500mm	420mm	950mm	6.0Kg	Yellow



**Plastic Fence Barrier | Blowing Type**

Perfect barrier for sporting events, festivals and parades;  
 With red, white or yellow color engineer grade reflective tape;  
 Lightweight and easy-to-handle; Great for indoor or outdoor use;  
 Includes connecting device to join units together;  
 Durable polyethylene construction with red, white or yellow reflective sheeting;  
 Legs clip into barrier for stacking, transportation and storage, can be adjustable in 360°;



Model No	Length	Base Width	Height	Body Height	Weight	Color
DH-PFB-1	2000mm	400mm	1000mm	800mm	12Kg	Orange/Yellow

**Australia Board Barrier**



**Two Type Trestle for options**

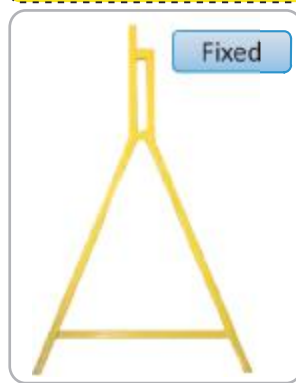

Model No	Part	length	Width	Height	Weight
<b>DH-BB-1</b>	Fixed Trestle	1000MM	715MM	50MM	3.0Kg Each
	Foldable Trestle	1000MM	200MM	50MM	3.5Kg Each
	Reflective Board	2500MM	190MM	30MM	2.5Kg

The Australia barrier board system is ideal for construction sites and outdoor applications where a tough and durable barrier system is required.  
 The yellow, ABS plastic board is supported by powdercoated steel legs. Length: 2.5metres.  
 The yellow boards with class 1 reflective stripes meet highway use requirements.

## Water Filled Barrier

Whether the requirement is to redirect, separate or delineate traffic, protect pedestrians from moving vehicles or provide a high visibility presence, our range of water filled safety barriers will provide you with many years of service and protection.



Model No	Length	Height	Top Width	Bottom Width	Weight	Water Capacity
WB-1	600mm	600mm	150mm	400mm	4Kg	60Kg
WB-5	1500mm	800mm	250mm	460mm	16.5Kg	250Kg
WB-8	1300mm	650mm	200mm	400mm	9.5Kg	200Kg



Model No	Length	Height	Top Width	Bottom Width	Weight	Water Capacity
WB-7	2000mm	800mm	145mm	400mm	19Kg	400Kg
WB-4	1650mm	650mm	150mm	450mm	12.5Kg	300Kg



## Plastic Convex Mirror

Made from PC Mirror and ABS Back.

1. Suitable for convenient shop, and big supermarket, parking lot and any other corner where need anti-thief.
2. Not easy to consume, anti-ultraviolet radiation, can use for a long time
3. Firm, long time using and anti-crash
4. Clear and definite mirror image, easy and convenient installation
5. Weight of the mirror is light, it can be safely used

### Indoor Type



Model No	Diameter
CM-20	200MM
CM-30	300MM
CM-45	450MM
CM-60-1	600MM
CM-80-1	800MM

### Outdoor Type



Model No	Diameter
CM-60-2	600MM
CM-80-2	800MM
CM-100	1000MM
CM-120	1200MM

## Stainless Safety Mirror

Made from Stainless Steel Mirror and Back.

### Benefits of Stainless Safety Mirrors

- Best-quality, premium products.
- Stainless material has no change of visibility (spots and cloudiness of mirror's surface).
- 3600 mm curvature radius meets the standards of the Ministry of Construction and Transportation.



1000 φ

800 φ

600 φ

Model NO	SCM-60	SCM-80	SCM-100
Mirror Diameter	600MM	800MM	1000MM
Curvature radius	2200M	3000MM	3600MM
Distance for visibility	≤40M	40-60M	≥60M



**Plastic Road Stud**

**Aluminium Road Stud**



Model No	Length	Width	Height	Reflector	Weight	Color
DH-RS-1	100mm	100mm	20mm	PC Prism	0.15Kg	White/Yellow
DH-RS-2	100mm	100mm	20mm	43 Bead Glass	0.15Kg	White/Yellow
DH-RS-2	100mm	100mm	70mm	PC Prism	0.30Kg	White/Yellow
DH-RS-3	100mm	100mm	70mm	43 Bead Glass	0.30Kg	White/Yellow

**Solar Road Stud**

**Plastic Solar Road Stud**



Model No	Length	Width	Height	Reflector	Weight	Color
DH-RS-5	108mm	101mm	22mm	6 Flash LED	0.30Kg	White/Yellow
DH-RS-9	132mm	122mm	70mm	6 Flash LED	0.80Kg	White/Yellow
DH-RS-6	115mm	184mm	70mm	4 Flash LED	0.50Kg	White/Yellow

**Temporary Road Marking**

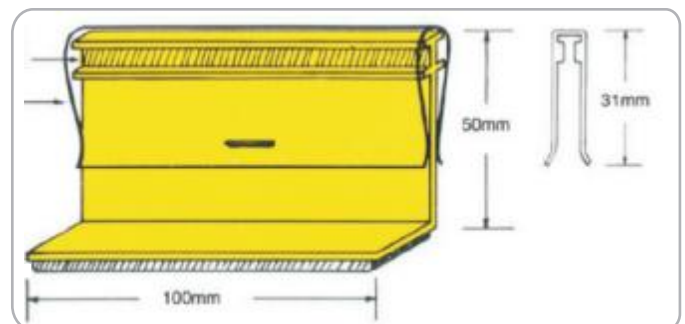

*Chip Seal Markers are the most economical choice for temporary lane markings. These markers can be installed quickly and easily by one worker with no equipment, providing huge savings in time, money and worker exposure vs. paint or temporary pavement marking tape.*

## GuardRail Reflector



Model No	DH-DE-1	DH-DE-2	DH-DE-3	DH-DE-4	DH-DE-5	DH-DE-6
Size	120x50x70mm	120x50x70mm	180x46x25mm	180x46x25mm	180x46x25mm	∅ 85mm
Materials	Aluminum	Aluminum	Aluminum	Aluminum	Plastic	Aluminum



## PVC Guide Post



Name	Model No	Height	Width	Reflector	Color
C-Shaped Flexible Post	DH-DE-8	1110mm	105mm	180x46mm	White/Yellow
Triangle Guide Post	DH-DE-11	1500mm	120mm	180x46mm	White/Yellow

1. Excellent impact resistance, the post made from PVC plastic.
2. Micro prismatic reflectors make its reflective lightness equal to diamond grade.



### Barricade Light



Model No	Height	Length	Width	Light Source	Drive Mode	Color
BL-1	330mm	180mm	75mm	6 LED	Dry Battery	Yellow/Red
BL-2	330mm	180mm	75mm	6 LED	Solar	Yellow/Red
BL-3	360mm	190mm	110mm	6 LED	Dry Battery	Yellow/Red
BL-4	330mm	180mm	75mm	6 LED	Dry Battery	Yellow/Red

90 degree angle lens offers increased visibility.  
Durable bottom casing to protect the battery compartment.  
One piece battery compartment works with gravity for better conductivity.



### Plastic Chain



Model No	Diameter	Unit Size	Length	Weight/Roll	Color
PC-4	4mm	25x18mm	50Meter/Roll	2.0Kg	Red/White
PC-6	6mm	41x21mm	50Meter/Roll	3.1Kg	Red/White
PC-8	8MM	50x26mm	50Meter/Roll	5.5Kg	Red/White
PC-10	10mm	54x39mm	25Meter/Roll	5.2Kg	Red/White

**Traffic Flag**

**Bunting Traffic Flag Line With Rope**

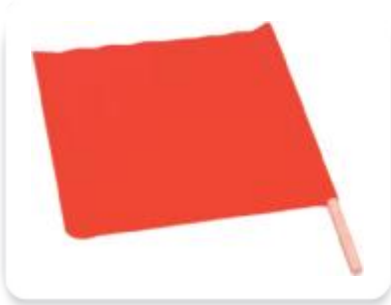

Reinforced warning flag promotes safety with high-visibility.

①.Nylon traffic flag features plastic reinforcement stays to stay unfurled and enhance its visibility with a wooden handle.

Flag Size: 46CM(18Inch) | 61CM (24Inch), Hold with 61CM(24Inch) / 76CM(30Inch) Wood Staff.

②.White nylon rope cord with 45pcs 26x18cm forange vinyl flags,UV stabilised rope 30m per roll.

**LED Traffic Baton**



Rugged Design. Shock & Weather Resistant .  
 Rubber "O" Ring Battery Compartment Seal .  
 1 Mile Visibility at Night-LowLight Conditions.  
 53CM Total Length / 3CM Diameter Lens.  
 240g Only With Batteries Installed .  
 Red Flash Solid On & Glow Mode .  
 Drived by 1pcs D battery.

**Anti Glare Panel**



Model No	Height	Width	Thickness	Weight	Color
AGS-800	800mm	200mm	50mm	1.0Kg	Green
AGS-900	900mm	220mm	50mm	1.3Kg	Green

### Caution StripeTape



Standard Width	Standard Length
50MM / 75MM	100Meter / Roll

### Caution Tape



Caution Tape are a quick & effective way to create a visual fortress around temporary hazards.

This lightweight tape can be tied, stapled or nailed to posts, fences or barricades. Ideal for outdoor or indoor application such as crowd and traffic control. BRC...

### Permanent Marking Tape



Permanent marking tape are Embedded micro glass beads both on surface ,has a durable,reflective & skidproof effect.Designed to stripe asphalt parking lots,roads,bike paths and any other area where the road will subject to heavy traffic flow and high visibility delineation is needed.

Available in yellow, white Blue and Green.  
Also available in 50MM,75MM,100MM...Width.  
50Meter Per Roll.  
Any other color can be custom-made.

### Hazard Warning Tape



A quick, easy and inexpensive way to mark aisles and physical hazards. This highly visible, pressure-sensitive vinyl tape is self-wound with a permanent adhesive, and is protected with an abrasion resistant clear laminate that resists oil, dirt and chemicals.

Available in Yellow/Black & Orange/White.  
Also available in 50MM,75MM,100MM...Width.  
50Meter Per Roll.  
Any other color can be custom-made.

## 5-Channel Cable Protector

Occasionally you just can't avoid running cables or hoses across the floor. To help with these applications we offer a cable protector designed to save your valuable cables and hoses from vehicle damage. These cable protectors also provide safe passage for vehicles across potentially hazardous cables.

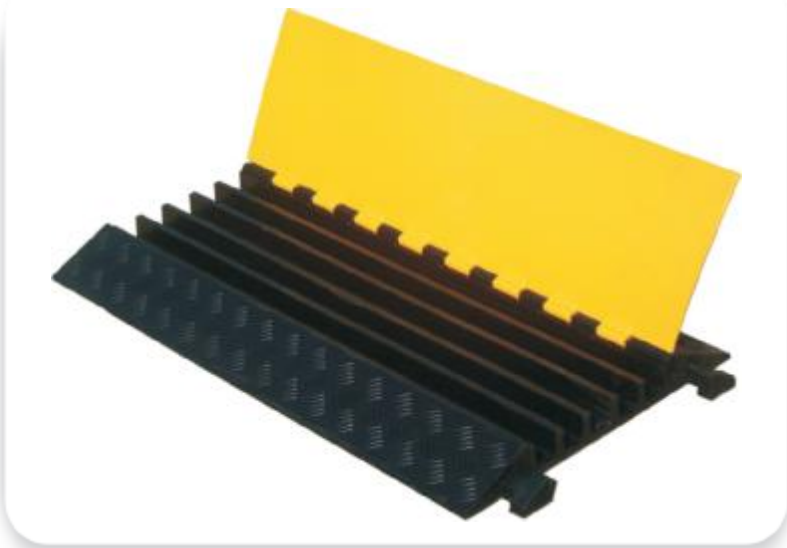

Model	Channel	Channel Size	Length	Width	Height	Weight
DH-CP-2	5	Ø42mmx5	900mm	500mm	55mm	16kg
Corner 22.5°	5	Ø42mmx5	310mm	500mm	55mm	4kg

For Heavy Traffic Application | Installable



Model	Channel	Channel Size	Length	Width	Height	Weight
DH-CP-3	5	Ø38mmx5	900mm	550mm	55mm	20kg

Cable Protectors with T-shaped connectors

### 4-Channel Cable Protector



Model	Channel	Channel Size	Length	Width	Height	Weight
DH-CP-8	4	50x38mm	900mm	600mm	58mm	18kg

### 3-Channel Cable Protector

For Heavy Traffic Application | Installable

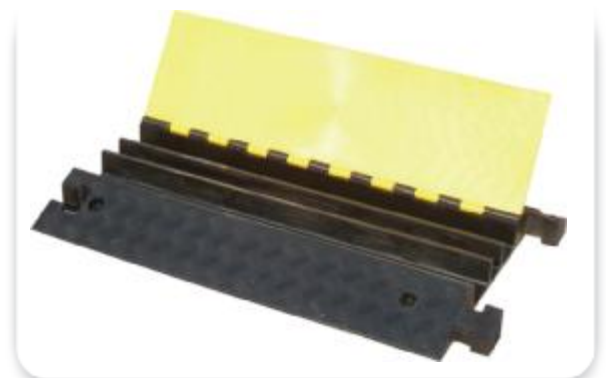
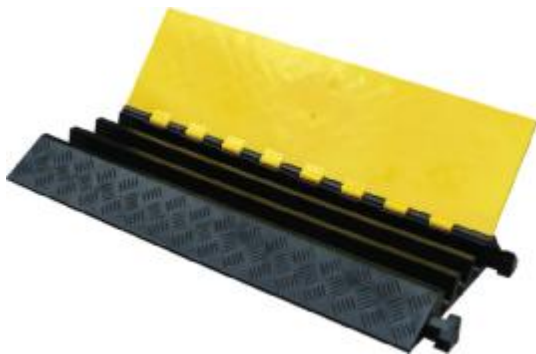

Model	Channel	Channel Size	Length	Width	Height	Weight
DH-CP-4	3	Ø65mmx3	900mm	500mm	75mm	20kg
Corner 22°5	3	Ø65mmx3	310mm	500mm	75mm	5kg
DH-CP-6	3	Ø65mmx3	900mm	600mm	75mm	25kg



## 2-Channel Economic Cable Protector

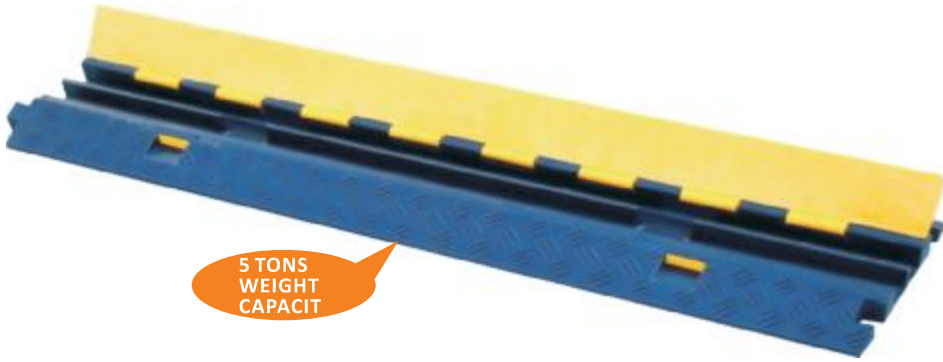

5 TONS  
WEIGHT  
CAPACIT



Model	Channel	Channel Size	Length	Width	Height	Weight
DH-CP-5	2	Ø30mmx2	1000mm	250mm	45mm	7.5kg
Corner45°	2	Ø30mmx2	400mm	250mm	45mm	2.5kg

## 2-Big Channel Cable Protector



Ask Testing Report Freely if want to know the bearing weight.

Model	Channel	Channel Size	Length	Width	Height	Weight
DH-CP-7	2	Ø90mmx2	900mm	615mm	105mm	28.5kg

Cable Protectors with T-shaped connectors



## PU 5-Channel Cable Protector

Made of Durable PU for light weight but longer service life!

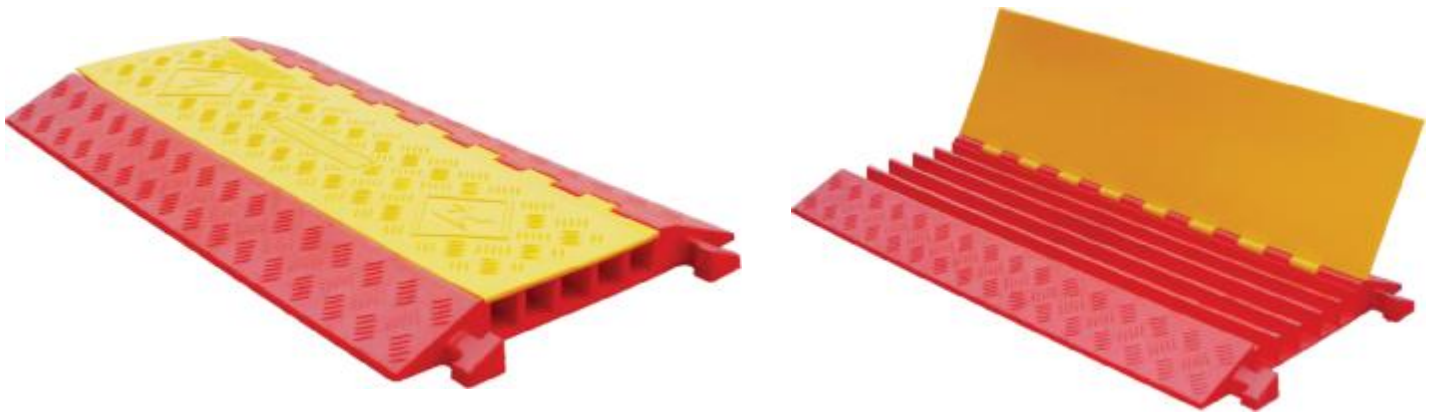

Model No	Length	Width	Height	Channel	Weight	Loading Capacity
DH-PCP-2	900MM	500MM	55MM	42x42MM	10.00Kg	40Tons Truck

### What's special about "Eastsea Rubber" PU Cable Protector?

**Designed for Home, Office, SuperMarkets and Indoor Area where need Clean Floor and Air (No Smell).**

Perfect solution for temporary events such as fairs, conventions, and trade shows;

Safety warning symbols molded into lid surface, with universal safety colors for high visibility;

Recessed Carrying Handle allows for moving with ease;

Easy to interlock Highly visible Orange / Yellow color Non-conductive construction;

Heavy duty Dog-Bone connector interlocks modular sections.



## PU Cable Protector

Made of Durable PU for light weight but longer service life!



Model No	Length	Width	Height	Channel	Weight	Loading Capacity
DH-PCP-4	900MM	500MM	75MM	65x65MM x 3	12.00Kg	40Tons Truck
DH-PCP-5	1000MM	250MM	45MM	35x35MM x 2	4.00Kg	12Tons Truck

### What's special about "Eastsea Rubber" PU Cable Protector?

**Designed for Home, Office, SuperMarkets and Indoor Area where need Clean Floor and Air (No Smell).**

Perfect solution for temporary events such as fairs, conventions, and trade shows;

Safety warning symbols molded into lid surface, with universal safety colors for high visibility;

Recessed Carrying Handle allows for moving with ease;

Easy to interlock Highly visible Orange / Yellow color Non-conductive construction;

Heavy duty Dog-Bone connector interlocks modular sections.

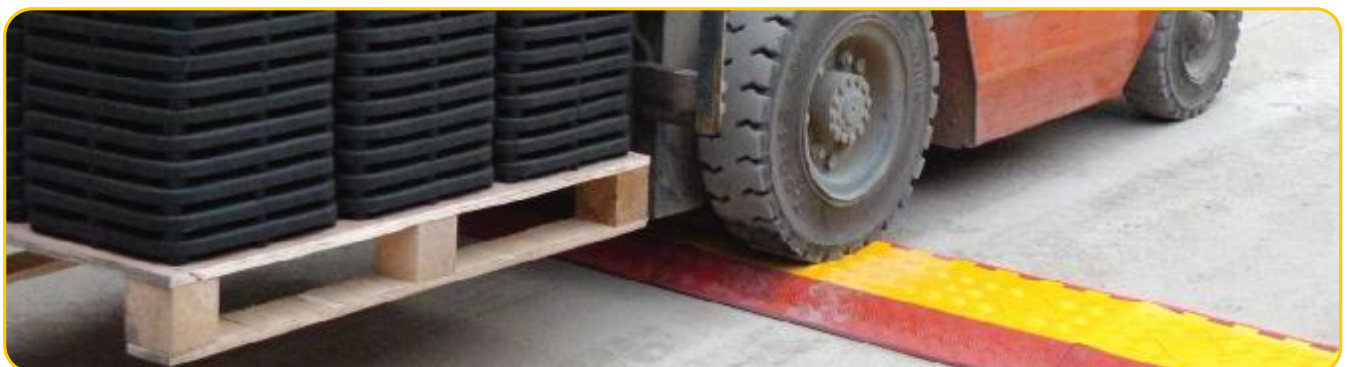

**Drop Over Cable Cover | For Foot & Light Traffic**

*Drop Over Cable Cover protect garage power cords, telephone lines and cables from vehicle and foot traffic. One Channel System simply drops over the cable and accepts one line up to 40x13mm and 105x25mm . They can be joined together with the L-Connector system to meet your different requirement in length.*



**COVER, HIDE AND PROTECT YOUR CABLES AND CORDS WHILE KEEPING FLOORS CLEAR AND SAFE.**

Model No	Length	Width	Height	Channel	Weight	Color
DH-CR3	1000mm	140mm	20mm	40x13mm	1.4Kg	Yellow
DH-CR4	1000mm	275mm	30mm	105x25mm	3.2Kg	Yellow

**Drop Over Cable Covers are made from durable Polyurethane  
 Heavy duty "L" shape connectors for easily attaching additional protectors to extend to any desired length.  
 Tread plate surface provides maximum traction for carts and pedestrian traffic.  
 These low profile protectors fit multiple cables sizes and are compact for easy set-up, take-down and storage.**



**Cord Protector** | For Foot Traffic

Cover, hide and protect your cables and cords while keeping floors clear and safe;  
 Their trim, lay-flat design provides a low profile;  
 This helps to reduce the possibility of tripping over exposed cords, wires,

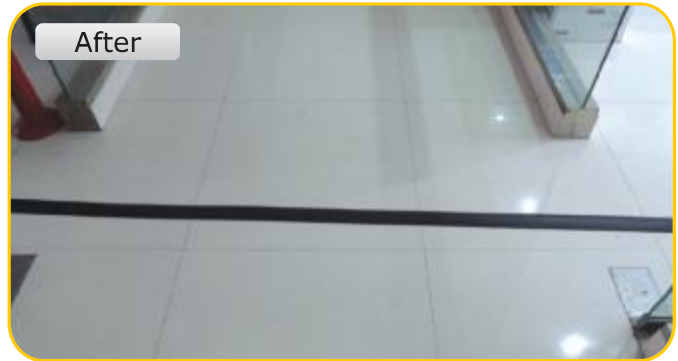

**COVER, HIDE AND PROTECT YOUR CABLES AND CORDS WHILE KEEPING FLOORS CLEAR AND SAFE.**

Model No	Length	Width	Height	Channel	Weight	Color
DH-COP-1	9000mm	64mm	11mm	16x6.4mm	4.8Kg	Black
DH-COP-2	9000mm	76mm	16mm	19x9.5mm	6.6Kg	Black
DH-COP-3	9000mm	76mm	25mm	38x16mm	9.0Kg	Black

Various lengths and widths to suit any application ;  
 Pre-slit for convenience and easy installation;  
 Multiple color options to customize your application;



## Hose Ramp

Hose Ramp is used for protecting hose and electric conduit runs with this effective, durable, long lasting product. Use to provide temporary or permanent hose and conduit runs from traffic. Also used to provide temporary ramp into driveways during construction along curbs. Lightweight and flexible, it conforms to contours of road surface. Economical and built to last, Enviroform hose ramps withstand

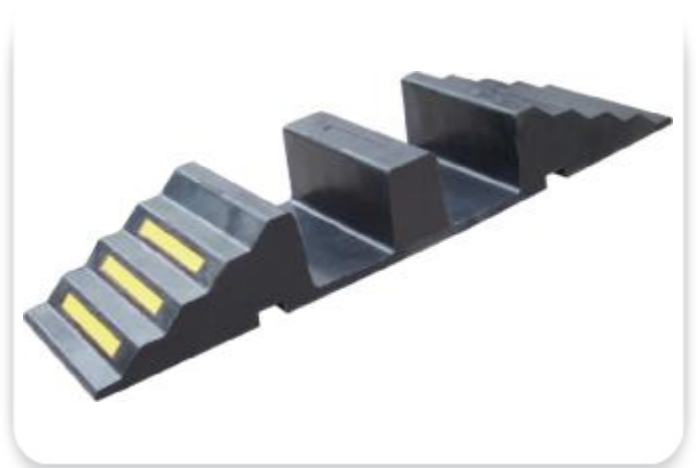

Model No	Length	Width	Height	Channel	Weight	Color
DH-HR-3	850mm	300mm	85mm	90x75mm	12Kg	Black /Yellow
DH-HR-5	1010mm	300mm	135mm	150x120mm	22Kg	Black /Yellow

## Hose Bridge



Double Reflector: Sheet and Cat-Eye

Model No	Length	Width	Height	Channel	Weight	Color
DH-HCR-4	855mm	300mm	125mm	100x100mm	19Kg	Black /Yellow



## Reflective Kerb Ramp

3 Different  
Height  
For your Options

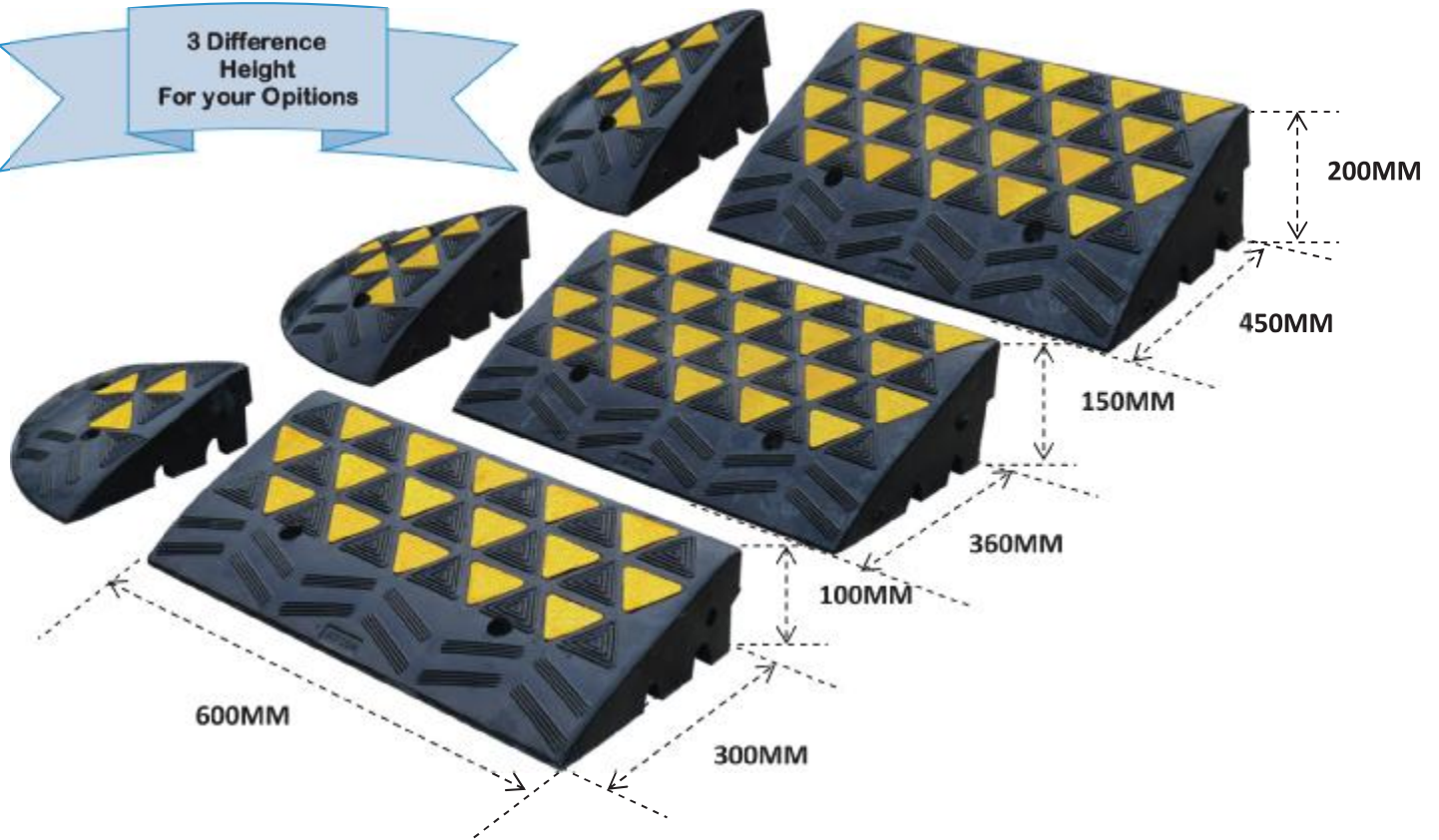

Model No	Part	Length	Width	Height
DH-UP-1	Middle	600MM	300MM	100MM
	End Cap	300MM		
DH-UP-2	Middle	600MM	360MM	150MM
	End Cap	360MM		
DH-UP-3	Middle	600MM	450MM	200MM
	End Cap	450MM		

### Why Using Kerb Ramp:

Using to bicycle, wheelchair's and Car ramp (Roadway <=> Sidewalk).

Easy to install / move and sustain performance of strength force up to 20 ton.

Available to keep the vehicle inside and using to install for emergency situation.

High performance of face grip and high brightness reflective sheet on the product



## Black Rubbe Kerb Ramp

Why Using Kerb Ramp:  
 Using to bicycle, wheelchair's and Car ramp  
 (Roadway <-> Sidewalk).  
 Available to keep the vehicle inside and using to  
 install for emergency situation.  
 High performance of face grip and high  
 brightness reflective sheet on the product



Model No	Part	Length	Width	Height	Weight
DH-UP-4	Middle	600MM	250MM	100MM	8.0Kg
	End Cap	250MM			12.5Kg



Model No	Part	Length	Width	Height	Weight
DH-UP-5	Middle	400MM	300MM	110MM	12Kg
DH-UP-6	Middle	500MM	300MM	140MM	14Kg
	End Cap	300MM			4.0Kg

## Rubber Threshold Ramp



Model No	Part	Length	Width	Height	Weight
DH-UP-5	Middle	400MM	300MM	110MM	12Kg

Rubber threshold ramps help you move through entryways by eliminating bumps to go over. To provide a smooth and secure transition, position the rubber threshold ramp against the door threshold.  
 Rubber threshold ramps for wheelchairs and scooters make the transition from inside to outside simple and they can be used on any type of surface.

## Rubber Wheel Chock

Wheel chocks are a must-have for any loading dock environment. Wheel chocks can save lives in the event a trailer begins to roll or shift while loading or unloading. This molded rubber wheel chock is sloped to increase holding capacity by allowing truck tires to roll on the chock face. The chock comes with rubber handle for convenient carry.



Model No	Length	Width	Height	Application	Weight	Color
DH-WC-1	260mm	160mm	190mm	Large Tire	3.0Kg	Black
DH-WC-2	210mm	250mm	220mm	Large Tire	6.5Kg	Black
DH-WC-3	300mm	320mm	260mm	Large Tire	12Kg	Black



## Plastic Wheel Chock



Model No	Length	Width	Height	Application	Weight	Color
DH-PWC-1	210mm	150mm	110mm	Car Tire	0.5Kg	Yellow

**Wheel Stop For Outdoor Parking Lot.**

Wheel Stop are fabricated from premium quality Recycle rubber. They have high resistance to severe impact & brutal weather conditions. They will help bring order to your residential and parking lots. These can be installed onto the ground of the allotted /painted Parking Slots to prevent the car from going beyond a certain limit thus protecting the wall / glass glazing structure & the car itself from damages.



Model No	Length	Width	Height	Reflector	Weight	Color
DH-PB-3	2000MM	150MM	100MM	Bead Tape	17Kg	Black /Yellow



Model No	Length	Width	Height	Reflector	Weight	Color
DH-PB-2	1830MM	150MM	100MM	Bead Tape	15Kg	Black /Yellow



Model No	Length	Width	Height	Reflector	Weight	Color
DH-PB-6	1650MM	160MM	100MM	Bead Tape	14Kg	Black /Yellow

**Wheel Stop For Outdoor / Indoor Parking Lot.**



**3 Foot Length**



Model No	Length	Width	Height	Reflector	Weight	Color
DH-PB-5	900MM	150MM	100MM	Bead Tape	7.0Kg	Black /Yellow

**Home Wheel Stop**



Model No	Length	Width	Height	Reflector	Weight	Color
DH-PB-4	550MM	150MM	100MM	Bead Tape	5.0Kg	Black /Yellow

**Bus / Truck Wheel Stop**



**Model No: DH-PB-7**

**Size: 550x150x150MM**

**Bead Tape: 80x150MM x 6 piece**

**Using for Bus / Truck Parking**



**Rubber Wheel Stop**



Model No	Length	Width	Height	Reflector	Weight	Color
DH-225	600MM	120MM	100MM	Bead Tape	5.0Kg	Black /Yellow
DH-PB-1	500MM	150MM	100MM	Bead Tape	5.0Kg	Black /Yellow



Model No	Length	Width	Height	Reflector	Weight	Color
DH-223	500MM	150MM	100MM	EPDM Rubber	5.0Kg	Black /Yellow
DH-222	500MM	150MM	100MM	EPDM Rubber	5.0Kg	Black /Yellow



Model No	Length	Width	Height	Reflector	Weight	Color
DH-221	500MM	150MM	100MM	EPDM Rubber	5.0Kg	Black /Yellow
DH-226	500MM	150MM	100MM	EPDM Rubber	4.0Kg	Black /Yellow

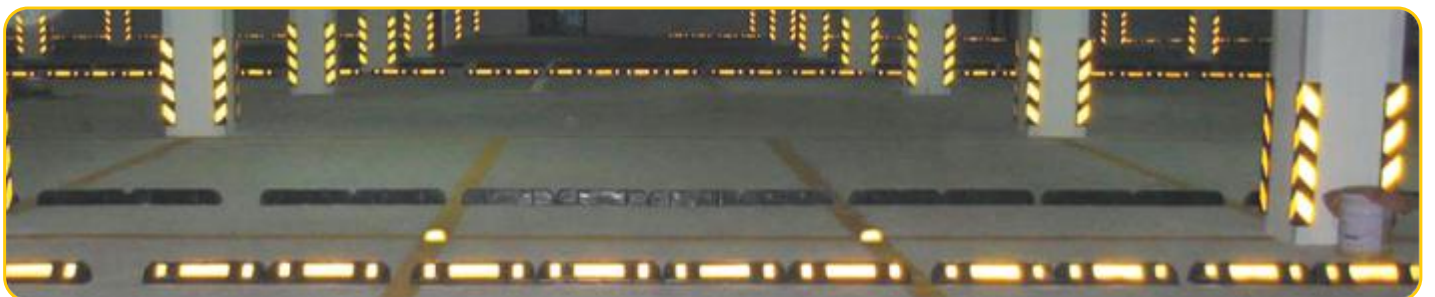

## Rubber Corner Guard

Corner guards are constructed from high impact resistance natural rubber. They are designed to protect the edges of columns in structures. Corner guards relieves the tension of chipped & broken corners of pillars / columns.



DH-128



DH-128L



DH-129  
~  
DH-132

*Any Color of Reflective Sheeting Are Available*

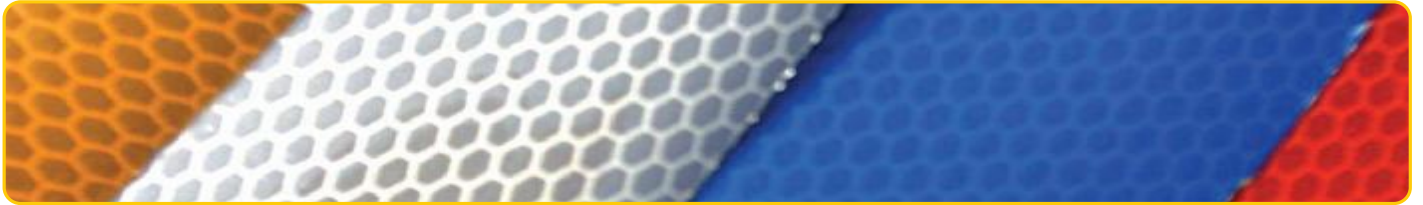

*All Size Of Rubber Corner Guard*

Model No	Item Name	Length	Width	Thickness	Weight
DH-128	Round Corner Guard [Heavy Duty]	800MM	120MM	20MM	2.6KG
DH-128L	Round Corner Guard [High Type]	900MM	100MM	20MM	2.5KG
DH-129	Square Corner Guard	800MM	100MM	12MM	2.2KG
DH-130	Square Corner Guard	800MM	100MM	10MM	2.0KG
DH-131	Square Corner Guard	800MM	100MM	8MM	1.8KG
DH-132	Square Corner Guard	800MM	80MM	20MM	3.0KG
DH-133	Square Corner Guard	600MM	80MM	20MM	2.0KG



## Wall Protector

Designed to absorb, deflect and minimize the extent of wear, abrasion and impact from wheeled traffic such as trolleys, carts and vehicles, heavy-duty rubber wall and corner profiles offer cost-effective protection for walls, corners and columns in busy assembly and access areas.



Model No	Length	Width	Height	Application	Weight	Color
DH-WP-4	1000mm	160mm	50mm	Parking Lot	5.0Kg	Black /Yellow
DH-WP-5	800mm	220mm	35mm	Garage	2.0Kg	Black /Yellow

Place each guard on the wall at its desired location, mark the wall with a pencil at each mounting hole. Remove the guard and drill a small hole at each mark, wipe down the wall to remove any dust and plaster. Replace the guard and attach to the wall with expansive screws.



**D-Type Dock Bumper**



*All models have predrilled, countersunk mounting holes for easy installation. Unique design and construction achieves high impact resistance and long life.*

Model No	Type	Length	Width	Height	Weight	Color
DB-100	D-Type	900mm	100mm	100mm	8Kg	Black
DB-150	D-Type	900mm	150mm	150mm	14Kg	Black
DB-200	D-Type	900mm	200mm	200mm	28Kg	Black



**Molded Dock Bumper**



Model No	Type	Length	Width	Height	Weight	Color
DH-1310	D-Type	330mm	250mm	102mm	8Kg	Black
DH-1810	D-Type	450mm	250mm	102mm	12Kg	Black

## Floor Sign | Cone

This Floor Cone is made from polypropylene and is bright and noticeable with warnings on both sides. The cone improves visibility by being taller than a standard 'A' board sign and by having a larger red sign on the top of it.



Model No	Name	Width	Height	Weight	Color
DH-FC	Floor Cone	280mm	670mm	1.1Kg	Yellow
DH-FC-SIGN	Top Sign	260mm	260mm	0.15Kg	Red
DH-FS-N	Parking Floor Sign	300mm	620mm	1.0Kg	Yellow
DH-FS-P	No Parking Floor Sign	300mm	620mm	1.0Kg	Yellow

## Rampway Anti-Skidding Mat

Rampway Anti-Skidding Mat are used in underground parking stations and rampways where increased traction is required to maintain safe driving conditions.



Model No	Length	Width	Height	Weight	Color
DH-RB-800	1000mm	800mm	50mm	30.0Kg	Black



## Removeable Safety Bollard

Our removable bollard offers an economical approach to controlling vehicle access. The bollard features two components, a bottom which is fixed onto ground and the stem which slots into the bottom. The bollard stem is secured by undercuts to the bottom. You can open the undercuts by key and remove the bollard stem at any time.



Model No	Bottom	Post	Height	Weight	Color
SB-M	200mm	100mm	500mm	3.50Kg	Black Yellow

## Parking Lock

Parking Lock and Position Lock was used to protect your parking space by standing guard while you and your vehicle are away. You can feel at ease that no vehicle can park in your space and inconvenience you.



O Type



A Type



K Type



T Type



I Type



M Type

Model No	Type	Length	Width	Original Height	Risen Height	Weight
PB-O	O	500mm	600mm	80mm	380mm	7.5Kg
PB-A	A	650mm	200mm	80mm	400mm	7.0Kg
PB-K	K	1000mm	85mm	80mm	190mm	7.5Kg
PB-T	T	495mm	495mm	90mm	495mm	7.0Kg
PB-I	I	74mm	90mm	90mm	690mm	6.0Kg
PB-M	M	680mm	290mm	50mm	410mm	2.5Kg

## Bike Rack



*Bike racks are architecturally distinctive and offer high bike security and protection from theft. All commercial grade Bike racks permit both the tire and frame to be locked with a standard lock.*

Name	Model No	Length	Width	Parking Space
Square Bike Rack	BR-S	1000MM	400MM	3 Bikes

